

垂直式快速夾鉗

Vertical quick clip

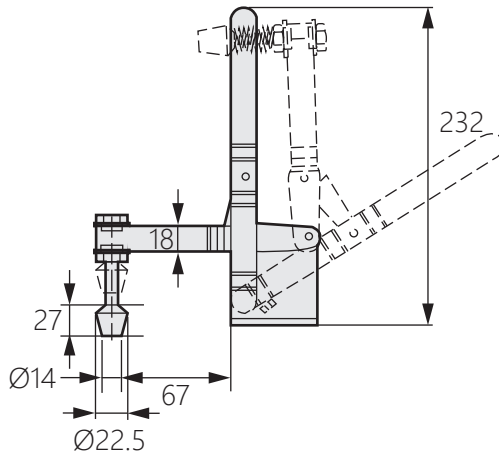

DK-8020H-7



商品介紹 Product description

1. 迫緊點高度可調節，以適應門板、門框的不同高度。
2. 壓把開啟角度=90度；手柄開啟角度=60度。

- 材質：鐵(SPCC)
- 表面處理：鍍鋅
- 用途：電箱、電櫃、工業設備。

1. The height of the pressing point can be adjusted to adapt to the different heights of the door panel and door frame.
2. Press the handle opening angle=90 degrees; handle opening angle=60 degrees.

- Material: Iron (SPCC)
- Finish: Zinc plated
- Uses: Electric box, electric cabinet and industrial equipment.

