

AC型交叉滾柱導軌

AC type crossed roller guide

HG-AC4



商品介紹 Product description

1. 安裝簡易方便。
2. 內有防蠕動齒輪，可防止保持架錯位。
3. 快速平穩的滾動運動。
4. AC4型交叉滾柱保持架的最大長度是300mm。

● 材質：導軌-軸承鋼、保持架-聚甲醛、鉻軸承鋼

1. Easy and convenient installation.
2. Equipped with anti-creep gears inside to prevent misalignment of the cage.
3. Fast and smooth rolling motion.
4. The maximum length of AC4 type crossed roller cage is 300mm.

● Material: Guide rail-bearing steel
Cage-POM、GCR15

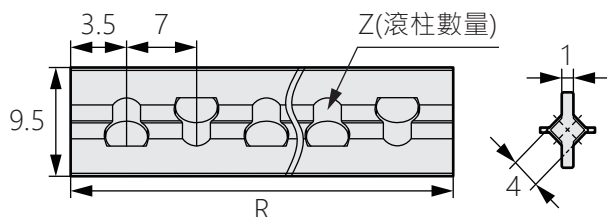
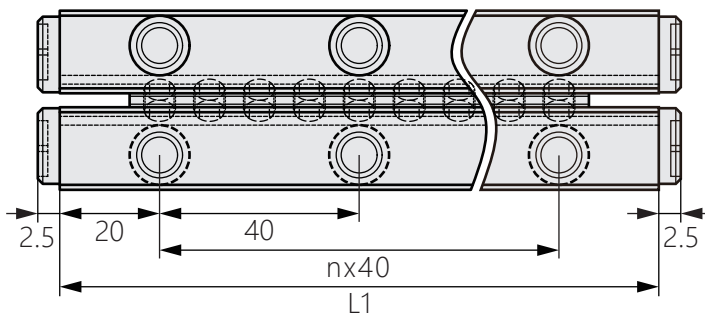
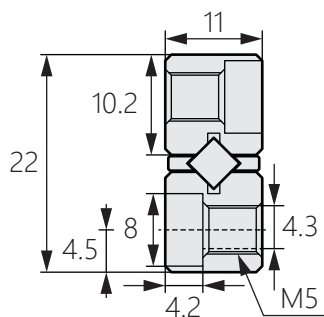

商品型號	L1	nx40	R	最大行程(mm)
HG-AC4-80X7Z	80	1x40	49	62
HG-AC4-120X11Z	120	2x40	77	86
HG-AC4-160X15Z	160	3x40	105	110
HG-AC4-200X19Z	200	4x40	133	134
HG-AC4-240X23Z	240	5x40	161	158
HG-AC4-280X27Z	280	6x40	189	182
HG-AC4-320X31Z	320	7x40	217	206
HG-AC4-360X35Z	360	8x40	245	230
HG-AC4-400X39Z	400	9x40	273	254
HG-AC4-440X43Z	440	10x40	301	278
HG-AC4-480X47Z	480	11x40	329	302