

CRW-H型交叉滾柱導軌

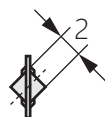

HG-CRW2-H

CRW-H type crossed roller guide

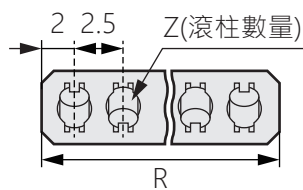
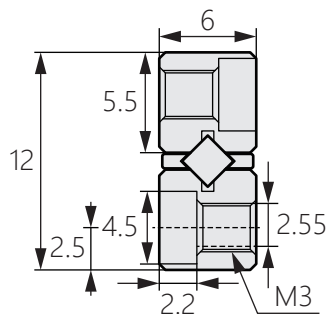

商品介紹 Product description

1. 安裝簡易方便。
2. 內有防蠕動齒輪，可防止保持架錯位。
3. 快速平穩的滾動運動。

● 材質：導軌-軸承鋼、保持架-不鏽鋼

1. Easy and convenient installation.
2. Equipped with anti-creep gears inside to prevent misalignment of the cage.
3. Fast and smooth rolling motion.

● Material: Guide rail-bearing steel
Cage-Stainless steel

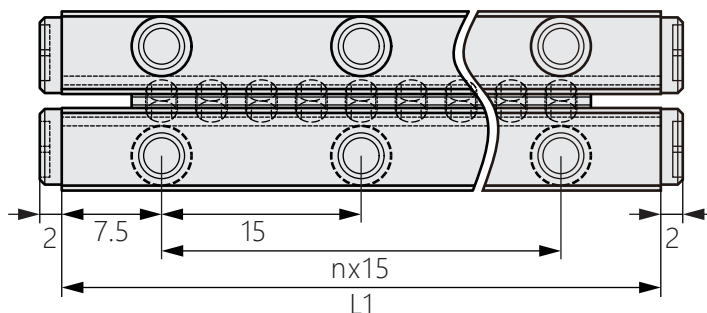

商品型號	L1	nx15	R	Z	最大行程(mm)
HG-CRW2-30HX8Z	30	1x15	20	8	20
HG-CRW2-45HX12Z	45	2x15	32	12	26
HG-CRW2-60HX17Z	60	3x15	44	17	32
HG-CRW2-75HX20Z	75	4x15	52	20	46
HG-CRW2-90HX25Z	90	5x15	64	25	52
HG-CRW2-105HX28Z	105	6x15	72	28	66
HG-CRW2-120HX33Z	120	7x15	84	33	72
HG-CRW2-135HX36Z	135	8x15	92	36	86
HG-CRW2-150HX41Z	150	9x15	104	41	92
HG-CRW2-165HX46Z	165	10x15	116	46	98
HG-CRW2-180HX51Z	180	11x15	128	51	104