

CRWG型防蠕動交叉滾柱導軌

CRWG-type anti-creeping cross roller guide



HG-CRWG2



商品介紹 Product description

1. 安裝簡易方便。
2. 內有防蠕動齒輪，可防止保持架錯位。
3. 快速平穩的滾動運動。

● 材質：導軌-軸承鋼、保持架-不鏽鋼

1. Easy and convenient installation.
2. Equipped with anti-creep gears inside to prevent misalignment of the cage.
3. Fast and smooth rolling motion.

● Material: Guide rail-bearing steel
Cage-stainless steel

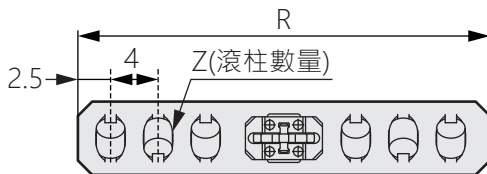
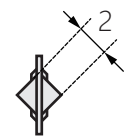
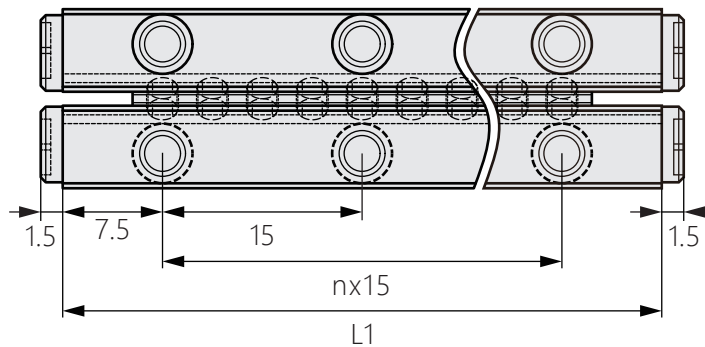
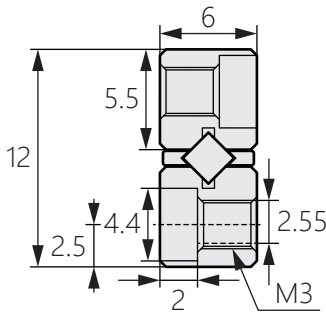
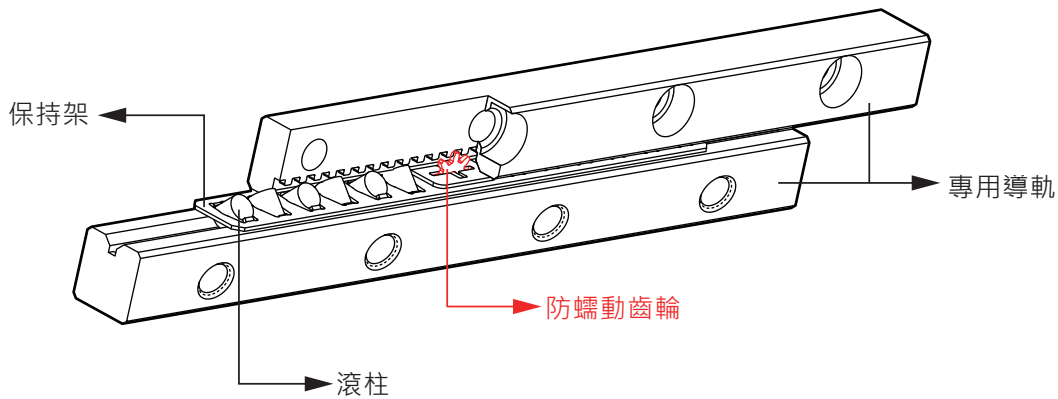

商品型號	L1	nx15	R	Z	最大行程(mm)
HG-CRWG2-30X4Z	30	1x15	24	4	12
HG-CRWG2-45X8Z	45	2x15	40	8	10
HG-CRWG2-60X10Z	60	3x15	56	10	24
HG-CRWG2-75X14Z	75	4x15	80	14	22
HG-CRWG2-90X16Z	90	5x15	104	16	36
HG-CRWG2-105X20Z	105	6x15	128	20	34
HG-CRWG2-120X22Z	120	7x15	152	22	48
HG-CRWG2-135X26Z	135	8x15	176	26	46
HG-CRWG2-150X28Z	150	9x15	200	28	60
HG-CRWG2-165X30Z	165	10x15	224	30	74
HG-CRWG2-180X32Z	180	11x15	248	32	88