

CRWG3型防蠕動交叉滾柱導軌

CRWG3-type anti-creeping cross roller guide



HG-CRWG3



商品介紹 Product description

1. 安裝簡易方便。
2. 內有防蠕動齒輪，可防止保持架錯位。
3. 快速平穩的滾動運動。

● 材質：導軌-軸承鋼、保持架-不鏽鋼

1. Easy and convenient installation.
2. Equipped with anti-creep gears inside to prevent misalignment of the cage.
3. Fast and smooth rolling motion.

● Material: Guide rail-bearing steel
Cage-stainless steel

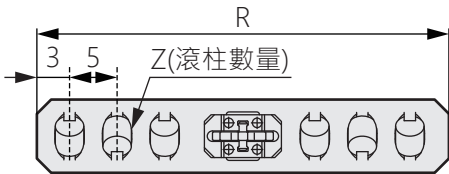
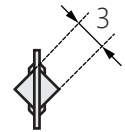
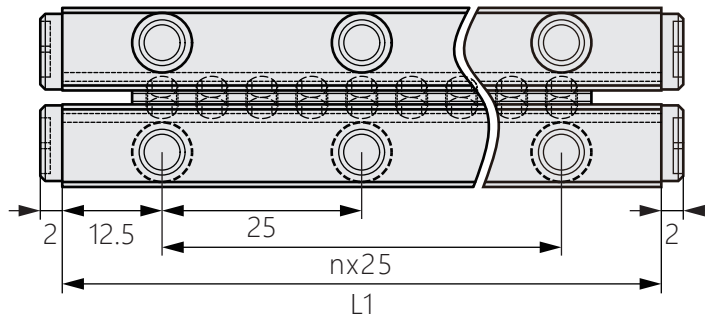
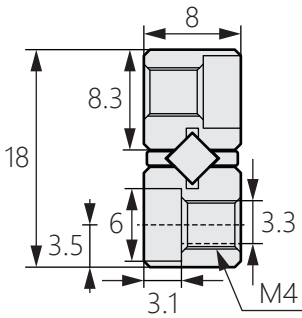
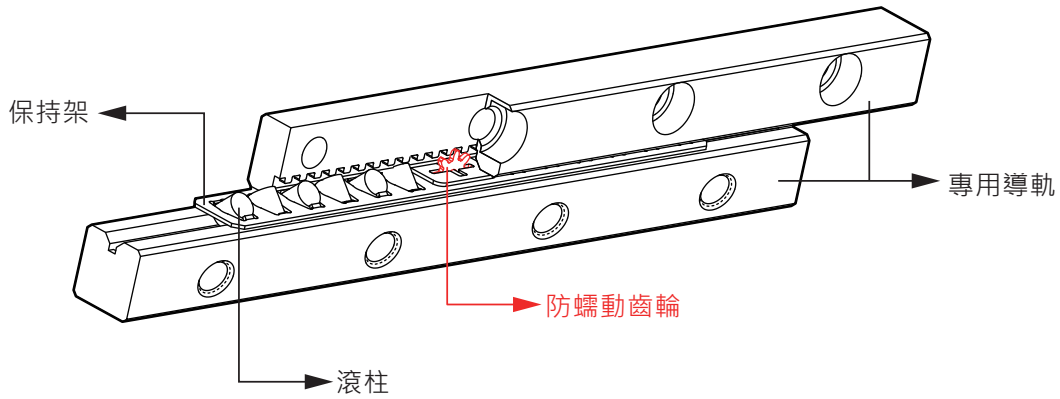

商品型號	L1	nx25	R	Z	最大行程(mm)
HG-CRWG3-50X6Z	50	1x25	40	6	20
HG-CRWG3-75X10Z	75	2x25	60	10	30
HG-CRWG3-100X14Z	100	3x25	80	14	40
HG-CRWG3-125X18Z	125	4x25	100	18	50
HG-CRWG3-150X22Z	150	5x25	120	22	60
HG-CRWG3-175X26Z	175	6x25	140	26	70
HG-CRWG3-200X30Z	200	7x25	160	30	80
HG-CRWG3-225X34Z	225	8x25	180	34	90
HG-CRWG3-250X38Z	250	9x25	200	38	100
HG-CRWG3-275X42Z	275	10x25	220	42	110
HG-CRWG3-300X46Z	300	11x25	240	46	120