

CRWM型三排交叉滾柱導軌

CRWM three-row crossed roller guide

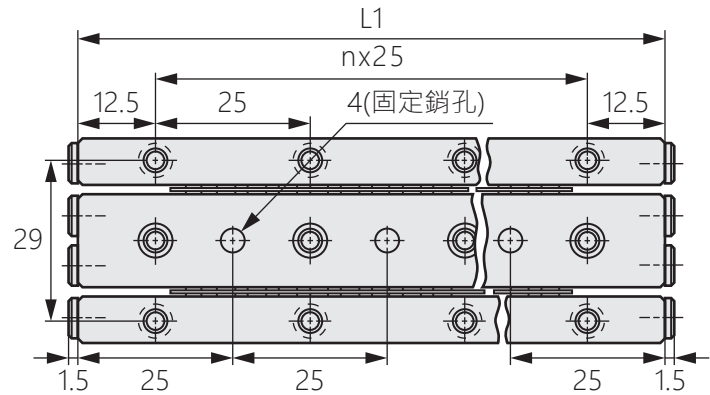

HG-CRWM3

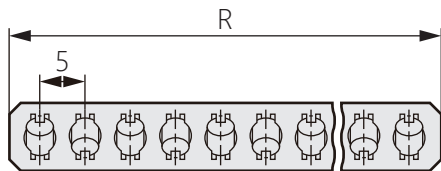
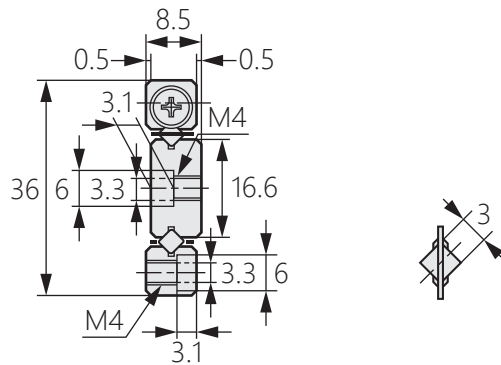

商品介紹 Product description

1. 安裝簡易方便。
2. 內有防蠕動齒輪，可防止保持架錯位。
3. 快速平穩的滾動運動。

● 材質：導軌-軸承鋼、保持架-不鏽鋼

1. Easy and convenient installation.
2. Equipped with anti-creep gears inside to prevent misalignment of the cage.
3. Fast and smooth rolling motion.

● Material: Guide rail-bearing steel
Cage-Stainless steel

商品型號	L1	nx25	R	Z	最大行程(mm)
HG-CRWM3-50X8Z	50	1x25	40	8	20
HG-CRWM3-75X12Z	75	2x25	60	12	30
HG-CRWM3-100X16Z	100	3x25	80	16	40
HG-CRWM3-125X20Z	125	4x25	100	20	50
HG-CRWM3-150X24Z	150	5x25	120	24	60
HG-CRWM3-175X28Z	175	6x25	140	28	70
HG-CRWM3-200X32Z	200	7x25	160	32	80
HG-CRWM3-225X36Z	225	8x25	180	36	90
HG-CRWM3-250X40Z	250	9x25	200	40	100
HG-CRWM3-275X44Z	275	10x25	220	44	110
HG-CRWM3-300X48Z	300	11x25	240	48	120