

CRWMG-H型三排防蠕動交叉滾柱導軌



HG-CRWMG2-H

CRWMG-H three-row anti-creep crossed roller guide 商品介紹 Product description



1. 安裝簡易方便。
2. 內有防蠕動齒輪，可防止保持架錯位。
3. 快速平穩的滾動運動。

● 材質：導軌-軸承鋼、保持架-不鏽鋼

1. Easy and convenient installation.
2. Equipped with anti-creep gears inside to prevent misalignment of the cage.
3. Fast and smooth rolling motion.

● Material: Guide rail-bearing steel
Cage-Stainless steel

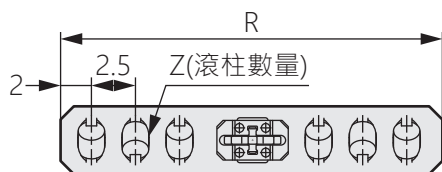
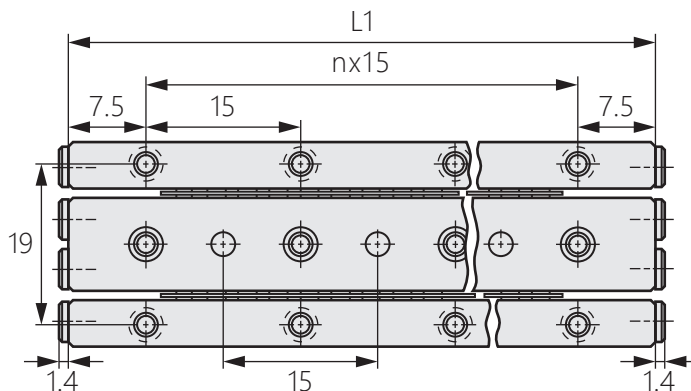
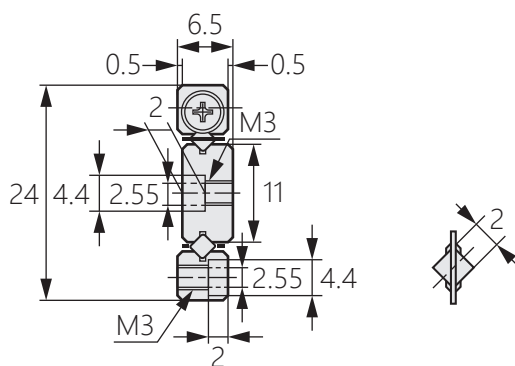

商品型號	L1	nx15	R	Z	最大行程(mm)
HG-CRWMG2-30HX4Z	30	1x15	24	4	12
HG-CRWMG2-45HX8Z	45	2x15	32	8	26
HG-CRWMG2-60HX12Z	60	3x15	40	12	40
HG-CRWMG2-75HX18Z	75	4x15	56	18	38
HG-CRWMG2-90HX22Z	90	5x15	64	22	52
HG-CRWMG2-105HX24Z	105	6x15	72	24	66
HG-CRWMG2-120HX30Z	120	7x15	88	30	64
HG-CRWMG2-135HX34Z	135	8x15	96	34	78
HG-CRWMG2-150HX38Z	150	9x15	104	38	92
HG-CRWMG2-165HX44Z	165	10x15	120	44	90
HG-CRWMG2-180HX46Z	180	11x15	128	46	104