

# CRWMG型三排防蠕動交叉滾柱導軌



## HG-CRWMG2

CRWMG three-row anti-creep crossed roller guide

商品介紹 Product description



1. 安裝簡易方便。
2. 內有防蠕動齒輪，可防止保持架錯位。
3. 快速平穩的滾動運動。

● 材質：導軌-軸承鋼、保持架-不鏽鋼

1. Easy and convenient installation.
2. Equipped with anti-creep gears inside to prevent misalignment of the cage.
3. Fast and smooth rolling motion.

● Material: Guide rail-bearing steel  
Cage-Stainless steel

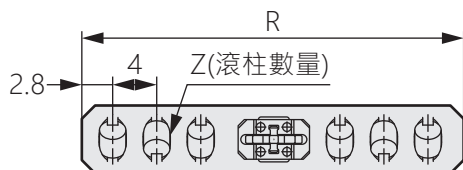
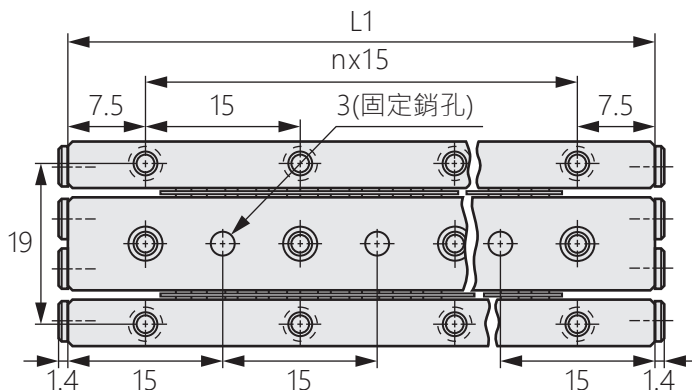
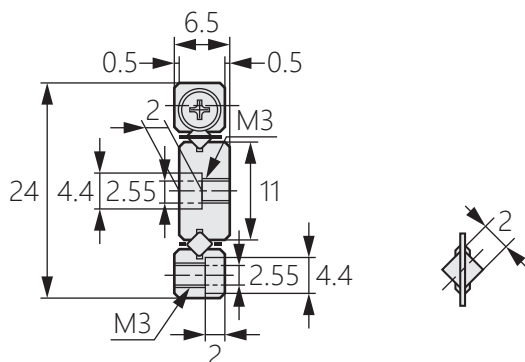

商品型號	L1	nx15	R	Z	最大行程(mm)
HG-CRWMG2-30X4Z	30	1x15	24	4	12
HG-CRWMG2-45X6Z	45	2x15	32	6	26
HG-CRWMG2-60X8Z	60	3x15	40	8	40
HG-CRWMG2-75X12Z	75	4x15	56	12	38
HG-CRWMG2-90X14Z	90	5x15	64	14	52
HG-CRWMG2-105X16Z	105	6x15	72	16	66
HG-CRWMG2-120X20Z	120	7x15	88	20	64
HG-CRWMG2-135X22Z	135	8x15	96	22	78
HG-CRWMG2-150X24Z	150	9x15	104	24	92
HG-CRWMG2-165X28Z	165	10x15	120	28	90
HG-CRWMG2-180X30Z	180	11x15	128	30	104