

CRWMG-H型三排防蠕動交叉滾柱導軌



HG-CRWMG3-H

CRWMG-H three-row anti-creep crossed roller guide 商品介紹 Product description



1. 安裝簡易方便。
2. 內有防蠕動齒輪，可防止保持架錯位。
3. 快速平穩的滾動運動。

● 材質：導軌-軸承鋼、保持架-不鏽鋼

1. Easy and convenient installation.
2. Equipped with anti-creep gears inside to prevent misalignment of the cage.
3. Fast and smooth rolling motion.

● Material: Guide rail-bearing steel
Cage-Stainless steel

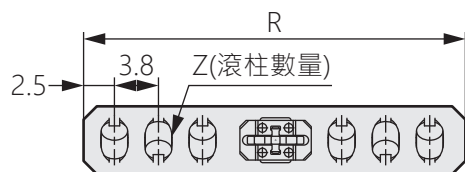
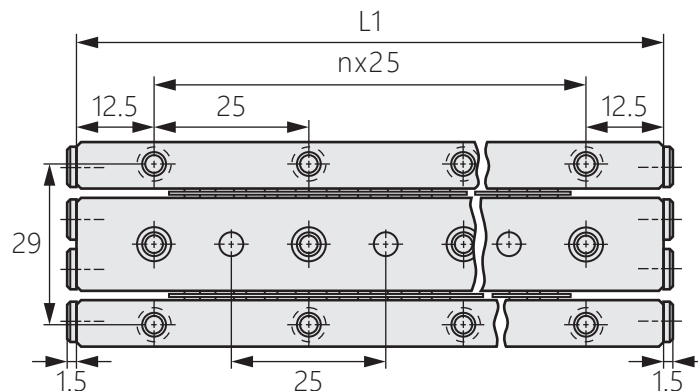
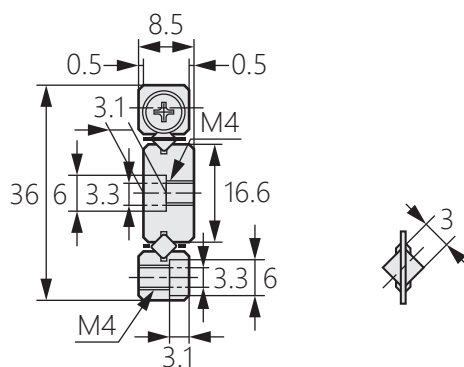

商品型號	L1	nx25	R	Z	最大行程(mm)
HG-CRWMG3-50HX8Z	50	1x25	40	8	20
HG-CRWMG3-75HX14Z	75	2x25	60	14	30
HG-CRWMG3-100HX20Z	100	3x25	80	20	40
HG-CRWMG3-125HX24Z	125	4x25	100	24	50
HG-CRWMG3-150HX30Z	150	5x25	120	30	60
HG-CRWMG3-175HX34Z	175	6x25	140	34	70
HG-CRWMG3-200HX40Z	200	7x25	160	40	80
HG-CRWMG3-225HX46Z	225	8x25	180	46	90
HG-CRWMG3-250HX50Z	250	9x25	200	50	100
HG-CRWMG3-275HX56Z	275	10x25	220	56	110
HG-CRWMG3-300HX60Z	300	11x25	240	60	120