

VB型交叉滾柱導軌



HG-VB2

VB type crossed roller guide



商品介紹 Product description

1. 安裝簡易方便。
2. 內有防蠕動齒輪，可防止保持架錯位。
3. 快速平穩的滾動運動。

● 材質：導軌-軸承鋼、保持架-不鏽鋼

1. Easy and convenient installation.
2. Equipped with anti-creep gears inside to prevent misalignment of the cage.
3. Fast and smooth rolling motion.

● Material: Guide rail-bearing steel
Cage-Stainless steel

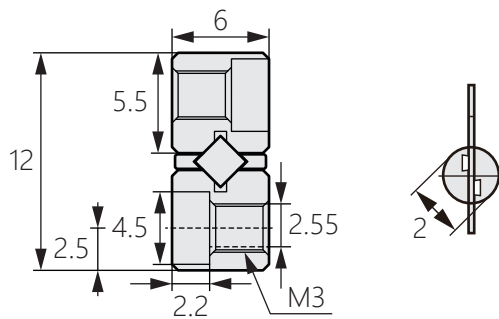
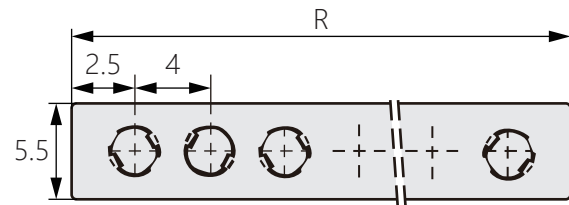
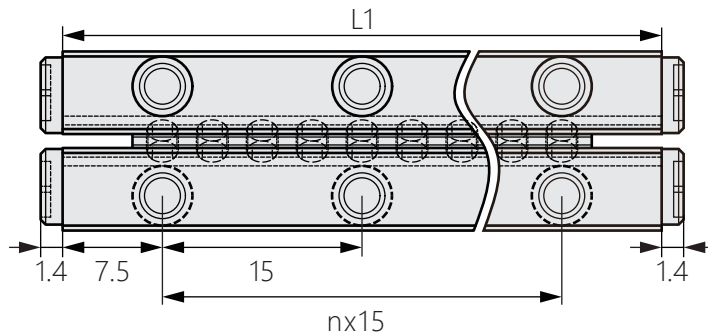

商品型號	L1	nx15	R	Z	最大行程(mm)
HG-VB2-30X5Z	30	1x15	20	5	20
HG-VB2-45X8Z	45	2x15	32	8	26
HG-VB2-60X11Z	60	3x15	44	11	32
HG-VB2-75X13Z	75	4x15	52	13	46
HG-VB2-90X16Z	90	5x15	64	16	52
HG-VB2-105X18Z	105	6x15	72	18	66
HG-VB2-120X21Z	120	7x15	84	21	72
HG-VB2-135X23Z	135	8x15	92	23	86
HG-VB2-150X26Z	150	9x15	104	26	92
HG-VB2-165X29Z	165	10x15	116	29	98
HG-VB2-180X32Z	180	11x15	128	32	104