

# VB型交叉滾柱導軌



## HG-VB3

VB type crossed roller guide



商品介紹 Product description

1. 安裝簡易方便。
2. 內有防蠕動齒輪，可防止保持架錯位。
3. 快速平穩的滾動運動。

● 材質：導軌-軸承鋼、保持架-不鏽鋼

1. Easy and convenient installation.
2. Equipped with anti-creep gears inside to prevent misalignment of the cage.
3. Fast and smooth rolling motion.

● Material: Guide rail-bearing steel  
Cage-Stainless steel

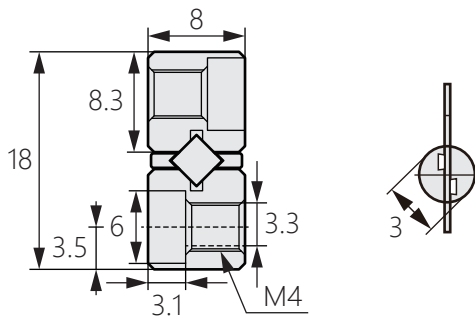
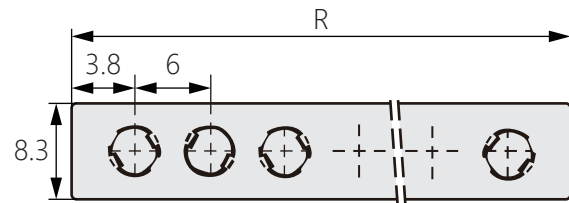
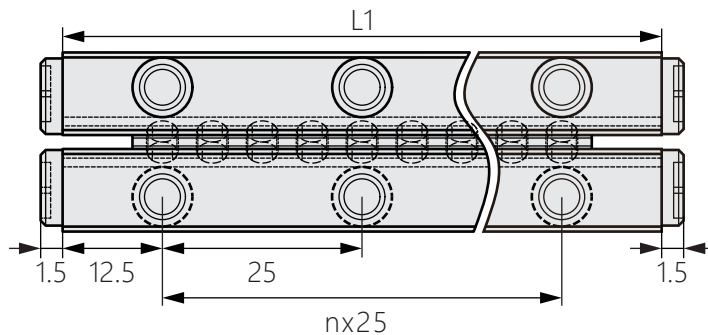

商品型號	L1	nx25	R	Z	最大行程(mm)
HG-VB3-50X7Z	50	1x25	42	7	16
HG-VB3-75X10Z	75	2x25	60	10	30
HG-VB3-100X14Z	100	3x25	84	14	32
HG-VB3-125X17Z	125	4x25	102	17	46
HG-VB3-150X21Z	150	5x25	126	21	48
HG-VB3-175X24Z	175	6x25	144	24	62
HG-VB3-200X28Z	200	7x25	168	28	64
HG-VB3-225X31Z	225	8x25	186	31	78
HG-VB3-250X35Z	250	9x25	210	35	80
HG-VB3-275X38Z	275	10x25	228	38	94
HG-VB3-300X42Z	300	11x25	252	42	96