

Nut baking rubber stopper

商品介紹 Product description

耐高溫：250°

- 材質：矽膠、硅膠
- 用途：用來安裝在牆上或安裝物上以安放螺絲

High temperature resistance: 250°

- Material: Silicone、Silica gel
- Uses: For mounting on a wall or on an installation to hold screws.

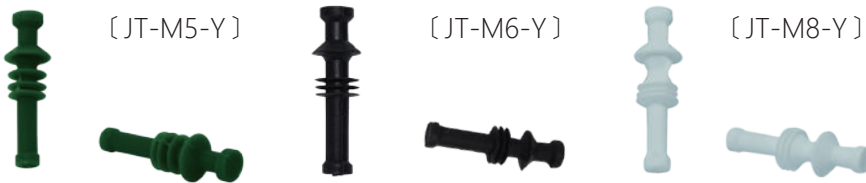

[JT-M3-G]

[JT-M8-Y]

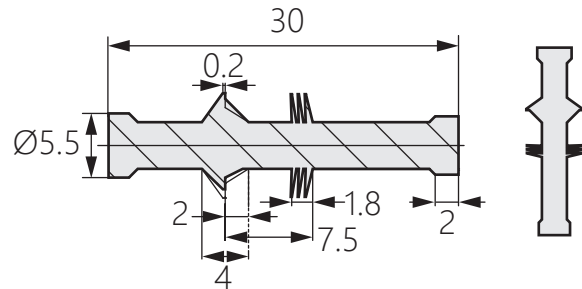
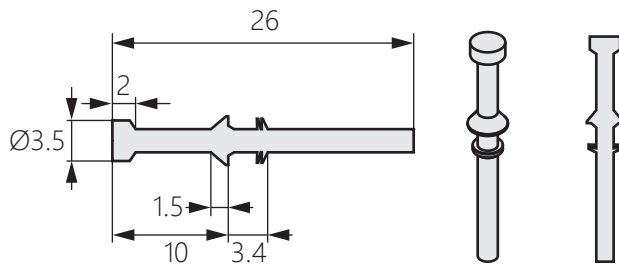

[JT-M4-Y]

局部放大

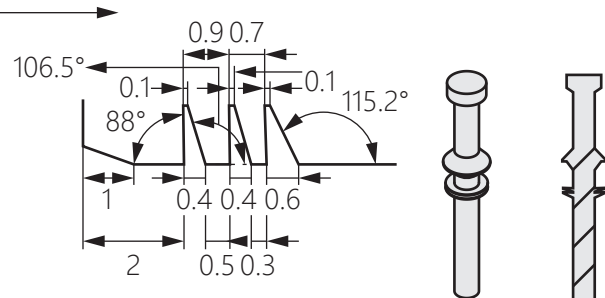
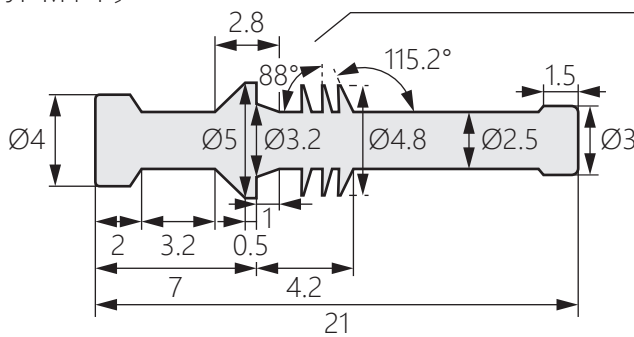

[JT-M5-Y]

局部放大

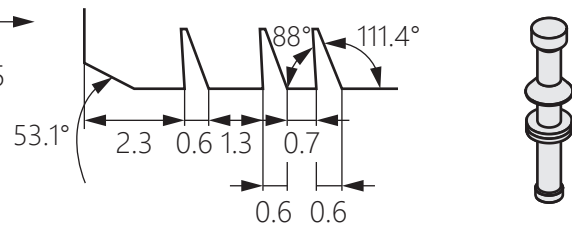
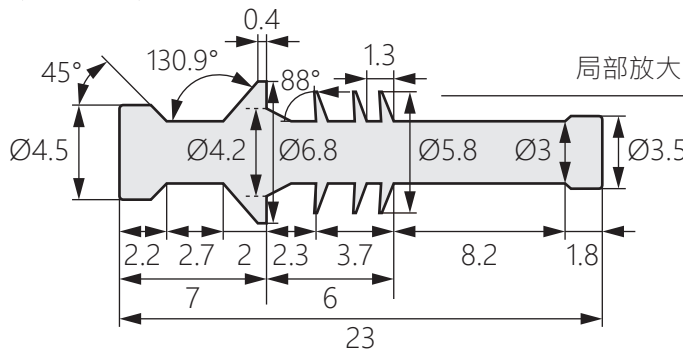

[JT-M6-Y]

局部放大

