



商品介紹 Product description

1. 開啟門板後，可自動回彈定位。
2. 預防工安產生時，可使門板保持關閉狀態。

- 材質：不鏽鋼
- 表面處理：震動研磨
- 用途：電子設備外殼、工業工箱等

1. After opening the door panel, it can automatically rebound and locate.
2. The door panel can be kept closed when preventing the occurrence of work safety.

- Material: Stainless steel
- Finish: Vibration grinding
- Uses: Electronic equipment shells, industrial work boxes, etc.

[OH-236-1]

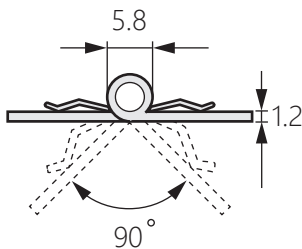
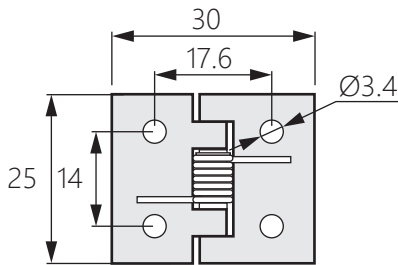

[OH-236-2]

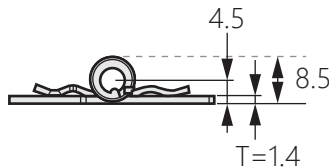
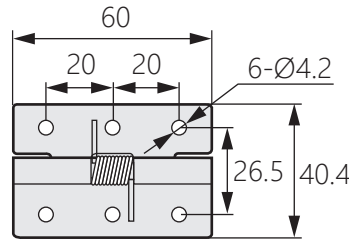

[OH-236-3]

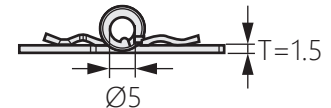
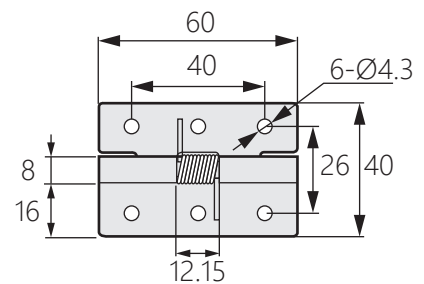

[OH-236-4]

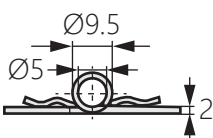
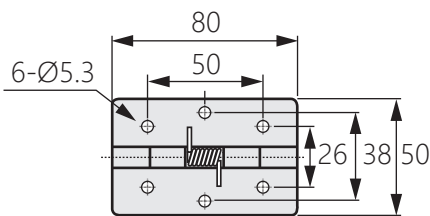

[OH-236-5]

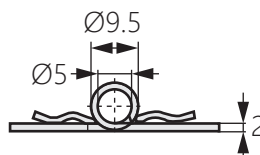
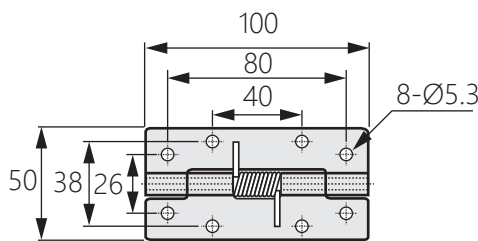

[OH-236-6]

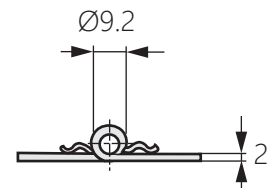
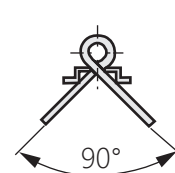
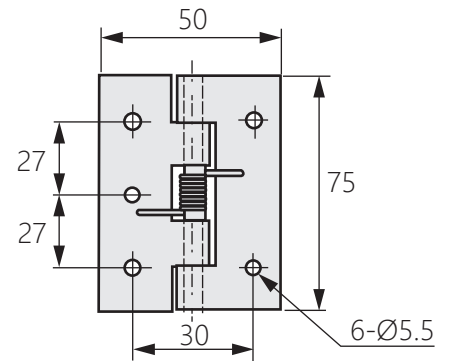

*只有OH-236-6是不鏽鋼304