

不鏽鋼鉸鏈

Stainless steel hinge

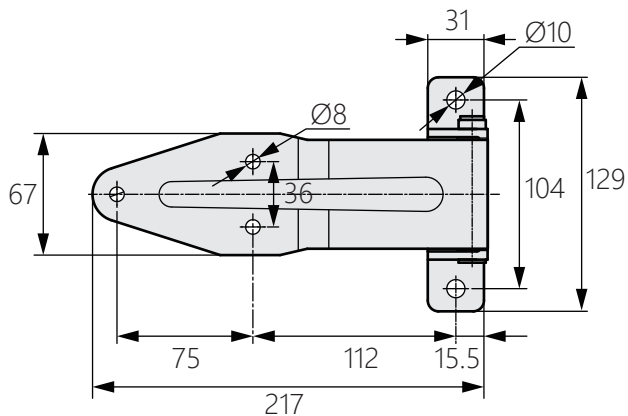

OH-323



商品介紹 Product description

- 1.由不鏽鋼製成，經久耐用且耐腐蝕。
- 2.負載荷重：50kgf。

- 材質：不鏽鋼(SUS304)
- 表面處理：拋光
- 用途：專用車輛、環境檢測設備等

- 1.Made of stainless steel for durability and corrosion resistance.
- 2.Load capacity: 50kgf.

- Material: Stainless(SUS304)
- Finish: Polishing
- Uses: Specially equipped vehicle,environmental testing equipment,etc.

