

自由止動鉸鏈

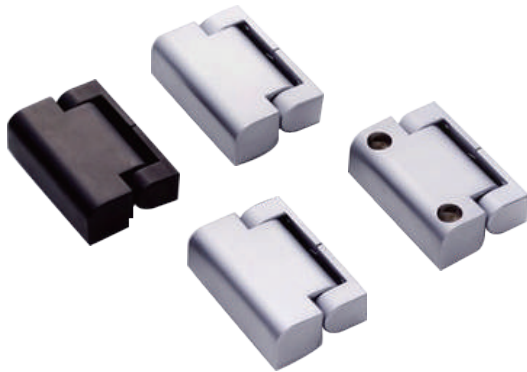

OH-340

Free stop hinge



商品介紹 Product description

- 1.可以停在特定位置的自由停止鉸鏈。
- 2.僅在恆定壓力下旋轉。(扭矩)

- 材質：鋅合金(ZDC)
- 表面處理：衛星鍍鉻、黑色鍍鉻、絲絨鍍鉻
- 用途：IT設備、配電盤等

- 1.It's a free-stop hinge that can be stopped at a particular position.
- 2.Rotate only at constant pressure.(Torque)

- Material: Zinc alloy(ZDC)
- Finish: Satellite chrome plating,black chrome plating,velour chrome plating
- Uses: IT equipment,switchboards,etc.

[OH-340-1]

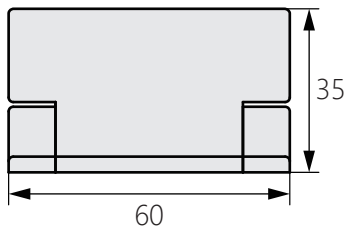

[OH-340-3]

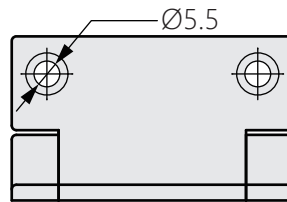

[OH-340-1-1D]

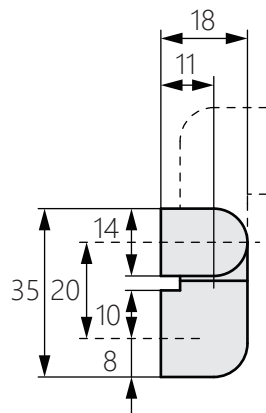
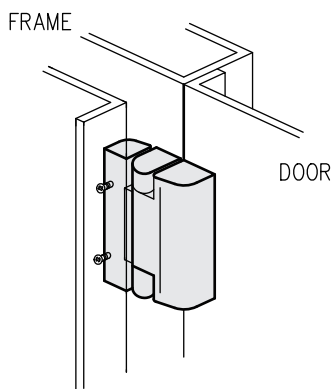
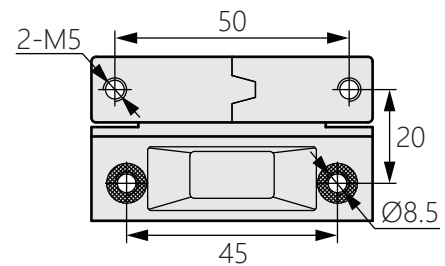
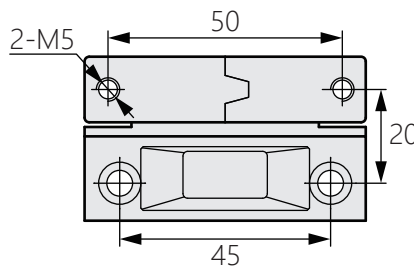
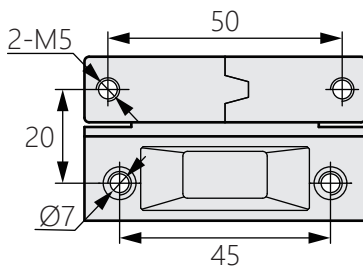

*D : O-RING插入式防水型

商品型號	扭力(kgf-cm)
OH-340-1-1	35±20%
OH-340-1-1D	35±20%
OH-340-1-2	45±20%
OH-340-2-1	35±20%
OH-341-2-2	45±20%
OH-341-3-1	35±20%
OH-341-3-2	45±20%
OH-341-4-1	35±20%
OH-341-4-2	45±20%