

切換開關取手



TG-332

Toggle switch



商品介紹 Product description

1. 適用在需要安全保護的設備上。
2. 允許機器直接監控開門，例如：緊急停止啟動、重置LED顯示狀態。

- 材質：取手-鋁合金、取手座-鋅壓鑄、蓋子-塑膠
- 備註：可選無按鈕T0、一個按鈕T1、兩個按鈕T2
例如：TG-332-1-B-T0。

1. Applicable to devices that require security protection.
2. Allow the machine to monitor the gate directly, Ex: emergency stop start, reset LED display status.

- Material: Toride-Aluminum alloy, Toride seat-Zinc die-casting, Lid-Plastic.
- Uses: Optional without button T0, one button T1, two buttons T2, Ex: TG-332-1-B-T0.

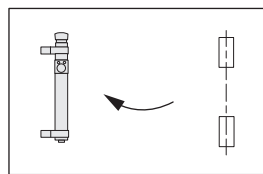
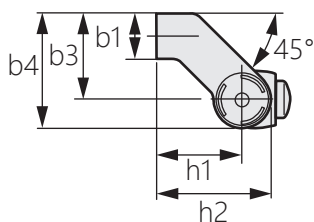

左側開門

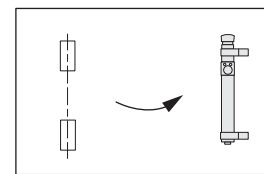

右側開門

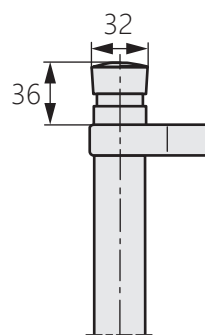
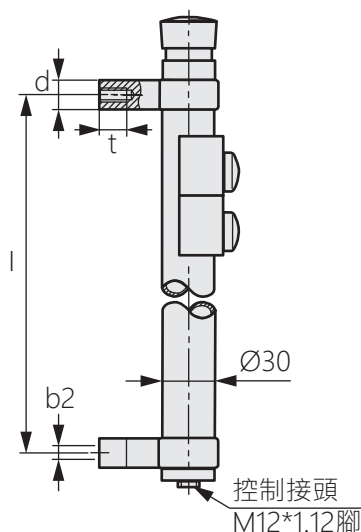

T0
無按鈕

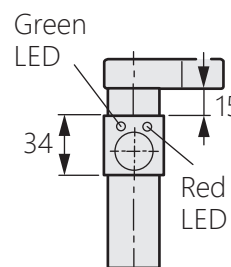

T1
1個按鈕

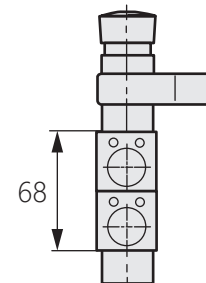

T2
2個按鈕

商品型號	l ±0.2	d	b1	b2	b3	b4	h1	h2	t
TG-332-1	200	M8	27	17	51	68	51	68	15
TG-332-2	300								

商品型號	取手	取手座	蓋子
TG-332-B	黑色	黑色	淺灰
TG-332-W	銀灰		