

氣密側手柄



TM-572

Side handle for airtight

商品介紹 Product description

左右兼用。

- 材質：鋅合金(ZDC)
- 表面處理：鍍鉻
- 用途：乾燥機、醫療儀器等

Use in both of right and left.

- Material: Zinc alloy(ZDC)
- Finish: Chrome plating
- Uses: Dryer,medical instrument,etc.

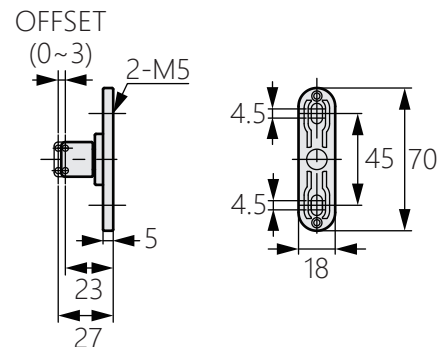
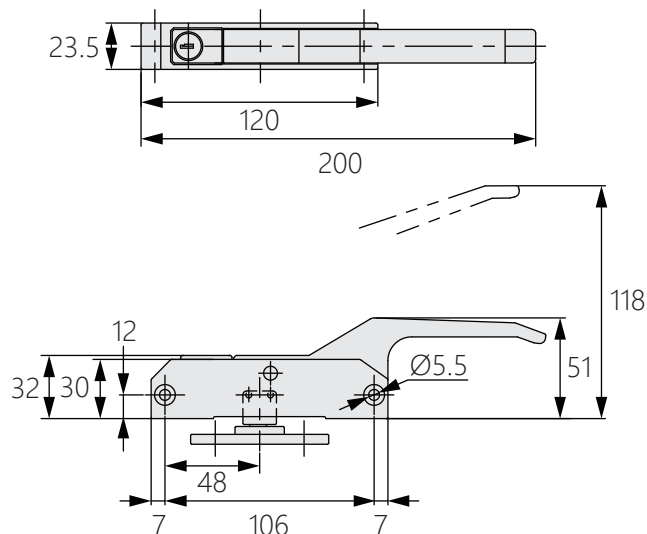

商品型號	樣式
TM-572-1	無鎖
TM-572-2	有鎖