

商品介紹 Product description

1. 抗振動。
2. 左右分開使用。

- 材質：鋅合金(ZDC)
- 表面處理：鍍鉻
- 用途：半導體設備、IT 設備

1. Resistant to vibration.
2. Use separately right and left.

- Material: Zinc alloy(ZDC)
- Finish: Chrome plating
- Uses: Semiconductor equipment, IT equipment.

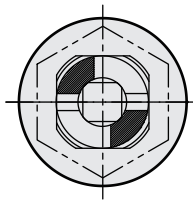
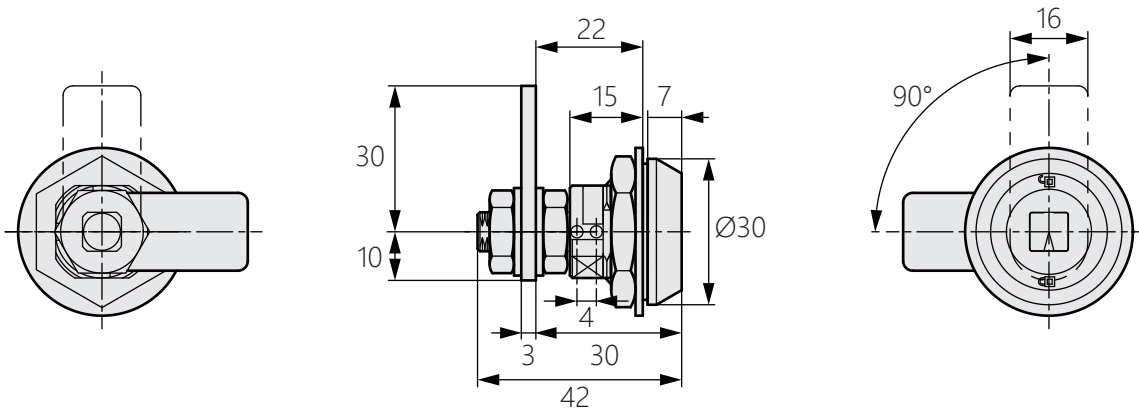

[RIGHT TYPE]

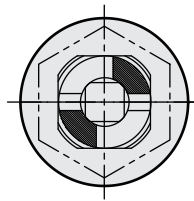

[LEFT TYPE]

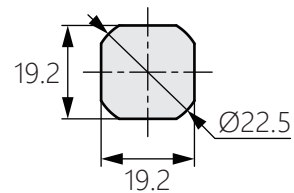

[開孔尺寸]

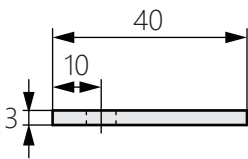

[TM-606-1]

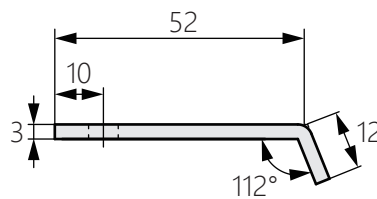

[TM-606-2]

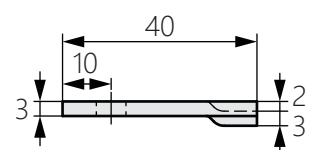

[TM-606-3]

商品型號			方向
TM-606-1R	TM-606-2R	TM-606-3R	右邊
TM-606-1L	TM-606-2L	TM-606-3L	左邊