

# 壓縮式門鎖



TM-8162

Compression door lock

商品介紹 Product description

大型·可調間距·

- 材質：鋅合金
- 表面處理：黑色塗裝、電鍍亮鉻
- 備註：多種鎖頭選擇·可選配擋片與取手(TM-2014)、防水蓋(TM-2015)

Large, adjustable pitch.

- Material: Zinc Alloy(ZDC)
- Finish: Black painting、bright chrome plating
- Note: Multiple lock options, optional stop, a variety of lock options, optional baffle and pick(TM-2014), waterproof cover(TM-2015).

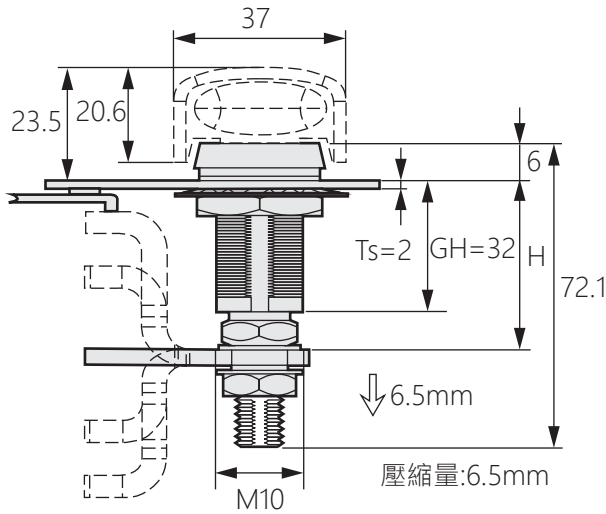

TM-2014

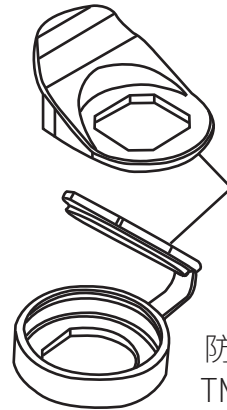

除了把手型  
其他可選配

防水蓋  
TM-2015

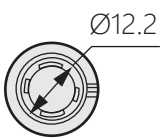
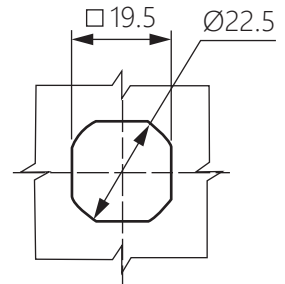
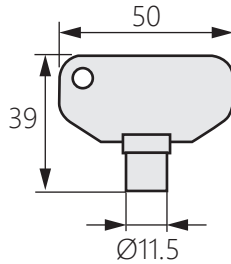
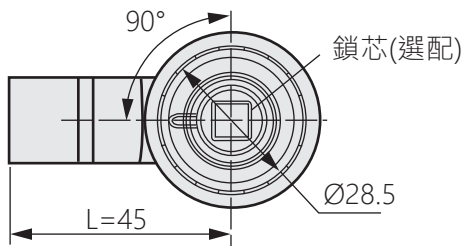

TM-8162-1  
鑰匙操縱型

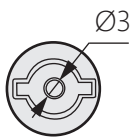

TM-8162-2  
雙翅型

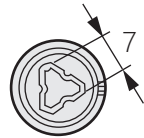

TM-8162-3  
三角7

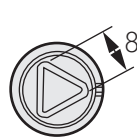

TM-8162-4  
三角8

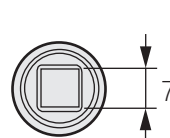

TM-8162-5  
四方7

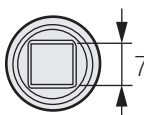

TM-8162-6  
四方8

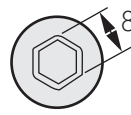

TM-8162-7  
內六角8

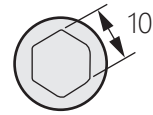

TM-8162-8  
外六角10

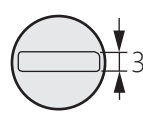

TM-8162-9  
一字槽型

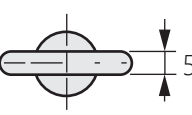

TM-8162-10  
把手型

擋片型號	間距	
	最小	最大
TH-1510	11.4	27.2
TH-2510	25.4	41.1
TH-3510	38.9	54.6
TH-4510	52.6	68.3
TH-5510	66.3	76.2